

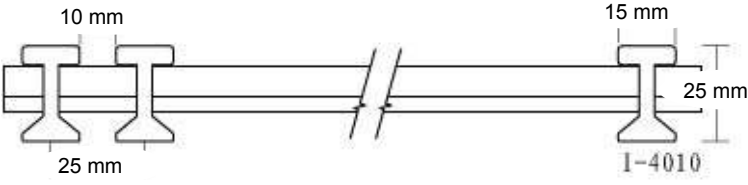

PULTRUDED (ÇEKME) IZGARALAR

PI-4010				
TAŞIYICI ÇUBUK ADEDİ	TAŞIYICI ÇUBUK ARALIĞI	BOŞ ALAN	AĞIRLIK KG/M2	YÜKSEKLİK
39	25mm	40%	17,10	25mm



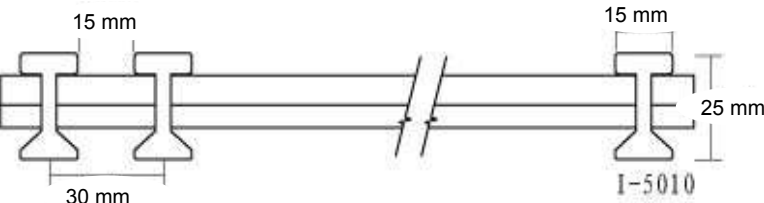

PI-5010				
TAŞIYICI ÇUBUK ADEDİ	TAŞIYICI ÇUBUK ARALIĞI	BOŞ ALAN	AĞIRLIK KG/M2	YÜKSEKLİK
33	30mm	50%	14,20	25mm



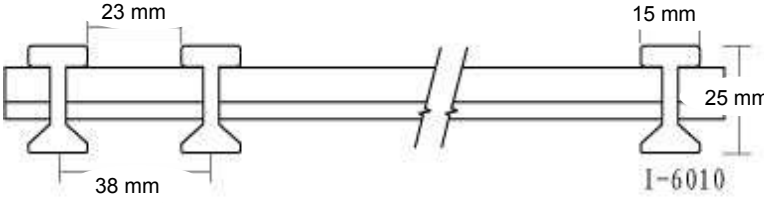

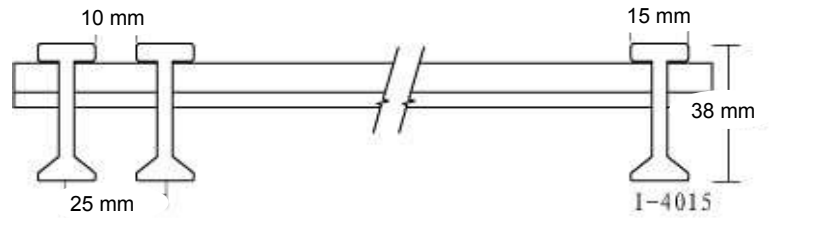
PI-6010				
TAŞIYICI ÇUBUK ADEDİ	TAŞIYICI ÇUBUK ARALIĞI	BOŞ ALAN	AĞIRLIK KG/M2	YÜKSEKLİK
26	38mm	60%	11,20	25mm



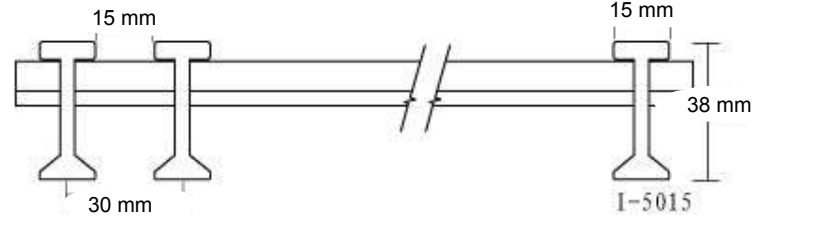

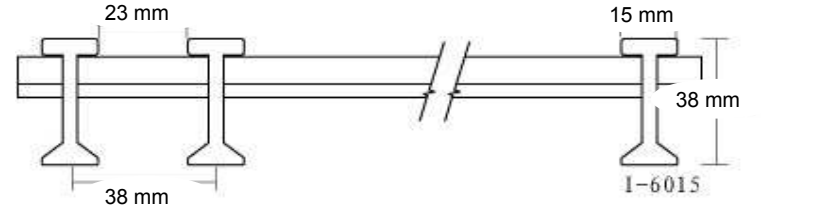
PI-4015					
TAŞIYICI ÇUBUK ADEDİ	TAŞIYICI ÇUBUK ARALIĞI	BOŞ ALAN	AĞIRLIK KG/M2	YÜKSEKLİK	
39	25 mm	50%	22,00	38mm	
					

PI-5015					
TAŞIYICI ÇUBUK ADEDİ	TAŞIYICI ÇUBUK ARALIĞI	BOŞ ALAN	AĞIRLIK KG/M2	YÜKSEKLİK	
33	30mm	50%	19,10	38mm	
					

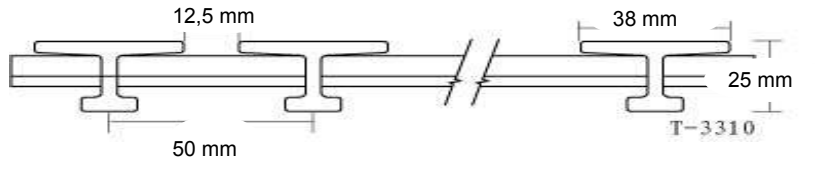
PI-6015					
TAŞIYICI ÇUBUK ADEDİ	TAŞIYICI ÇUBUK ARALIĞI	BOŞ ALAN	AĞIRLIK KG / M2	YÜKSEKLİK	
26	38mm	60%	16,10	38mm	
					

PT-3310					
TAŞIYICI ÇUBUK ADETİ	TAŞIYICI ÇUBUK ARALIĞI	BOŞ ALAN	AĞIRLIK KG/M2	YÜKSEKLİK	
20	50mm	33%	12,20	25mm	
					

PT-3320					
TAŞIYICI ÇUBUK ADETİ	TAŞIYICI ÇUBUK ARALIĞI	BOŞ ALAN	AĞIRLIK KG/M2	YÜKSEKLİK	
26	38mm	33%	20,27	50mm	
					

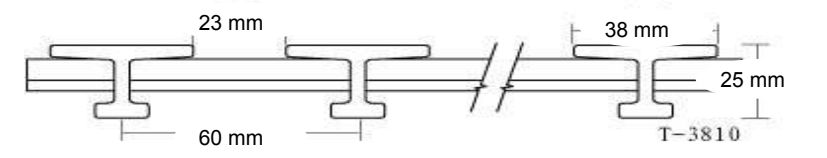
PT-3810					
TAŞIYICI ÇUBUK ADETİ	TAŞIYICI ÇUBUK ARALIĞI	BOŞ ALAN	AĞIRLIK KG/M2	YÜKSEKLİK	
16	60 mm	38%	11,20	25mm	
					

PT-5020					
TAŞIYICI ÇUBUK ADETİ	TAŞIYICI ÇUBUK ARALIĞI	BOŞ ALAN	AĞIRLIK KG/M2	YÜKSEKLİK	
20	50mm	50%	15,7	50mm	
